

# チョウ Butterfly

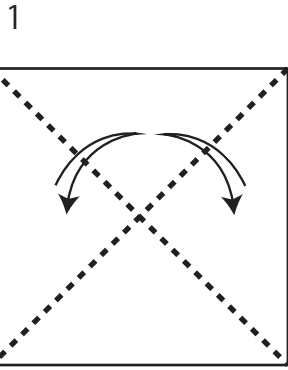

折り図：竹内ケイ  
Diagrams: TAKEUCHI Kei



オリスジを付ける

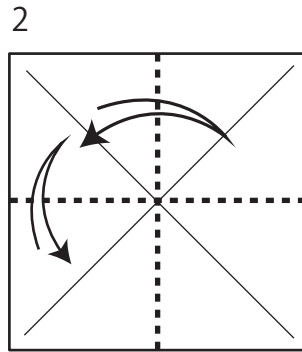

オリスジを付ける



裏返す

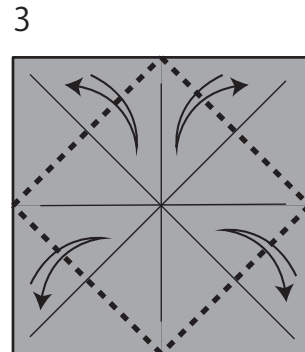

オリスジを付ける



裏返す

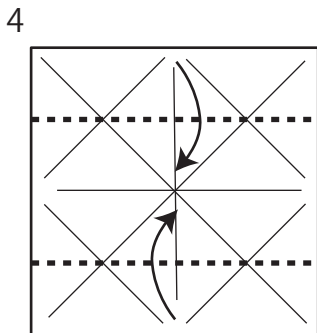

拡大

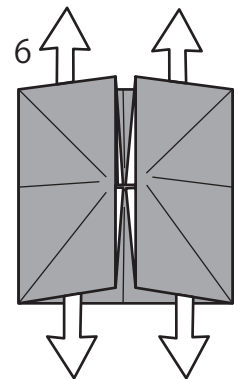
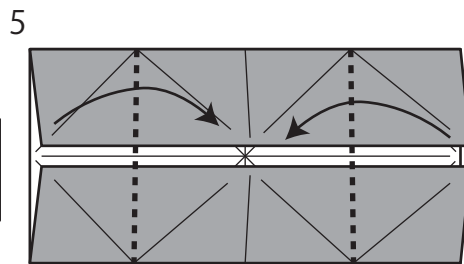

引っ張り出す

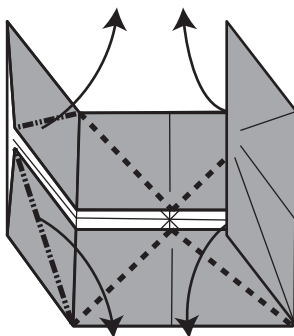

途中の図

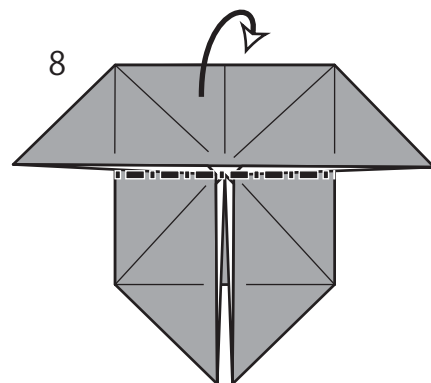
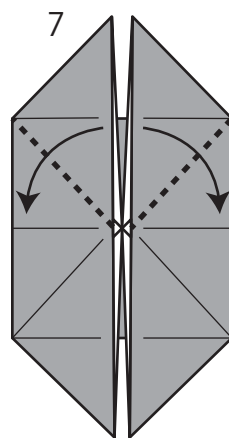

山折り

9

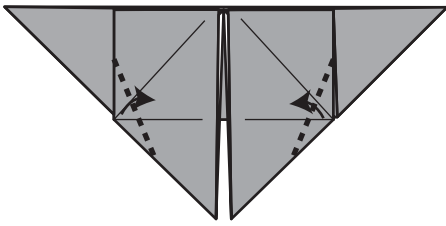

10

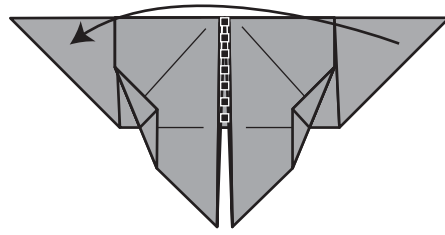

11

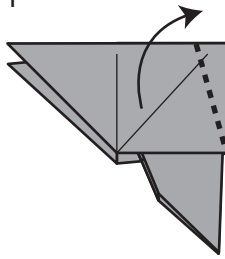

オリスジをしっかりつけて  
軽く広げる  
反対側も同じ

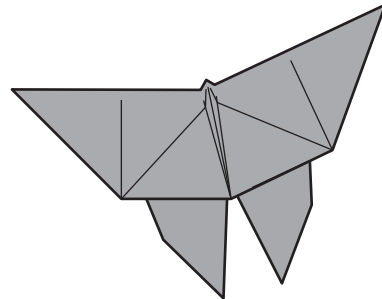

完成